

## Company Profile

MICOTA TECH (China) Co., Ltd. is a foreign invested company, specialized in producing highest of architectural hardware and lock more than 30 years since UK/ Taiwan. The new premise covers 40 English acres with a total investment of USD 50 millions. Micota focuses on quality, environmental friendly and high-tech's architectural hardware ,smart lock innovation. The company now has five registered trademark and over 30 design patents. The product line includes door and window hardware, security cylinders, CE fire proof locks, security locks, intelligent locks ,common door locks. We are long been in manufacturing partner with major world class brands customers with innovative products by our highly trained team. As always, we will work for better life for future!

MICOTA TECH (CHINA) CO.,LTD  
ADD:NO.888 Yanjia Rd.Yuantong Industrial  
TEL:+86-0573-8698-8888  
FAX:+86-0573-8698-8800  
Email:info@micota-tech.com  
Web:www.micota.net

MICOTA TECH (UK) CO.,LTD  
ADD:9A Railway Street Chelmsford Essex CM1 1QS  
United Kingdom  
TEL:+441376777021  
Email:info@antispacylinder.co.uk  
Web:antispacylinder.com

MICOTA TECH (TAIWAN) CO.,LTD  
ADD:4F.No.314 CHI-LIN RD.,TAIPEI,TAIWAN(R.O.C)  
TEL:+886(02)2562-4007  
FAX:+886(02)2562-9634  
Email:info@micota-tech.com  
Web:www.micota.net



# MICOTA®

Easy access by "touch"



**LEAD BY DESIGN , NEVER FOLLOW**

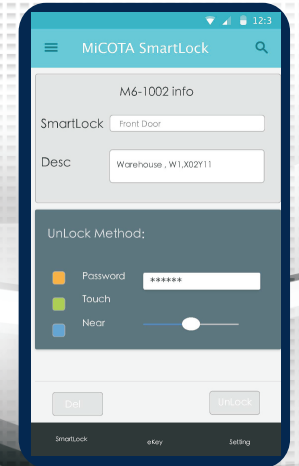
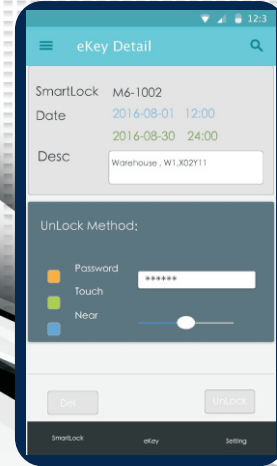
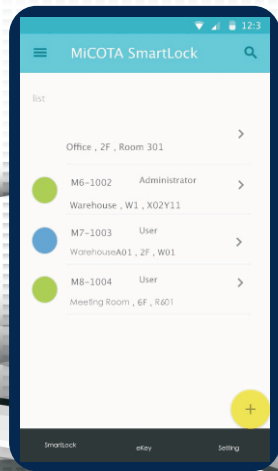
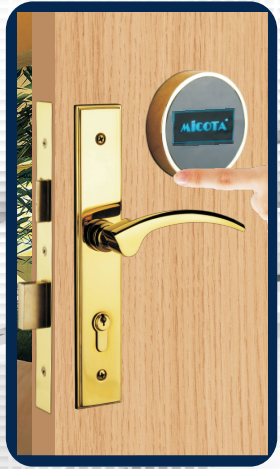

• Direct touch opening



• APP opening

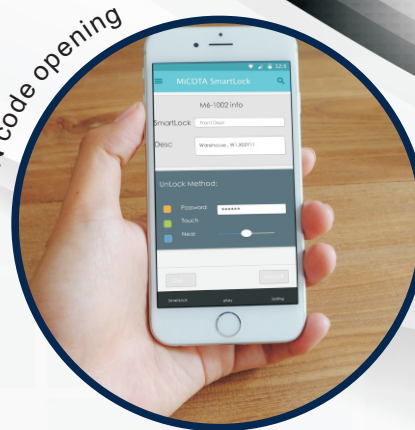

• APP PIN code opening



• Remote security (e-key)

**LEAD BY DESIGN , NEVER FOLLOW**

BL-01



Approximative access display OLED module



Bluetooth module and power unit

APP for Android / IOS

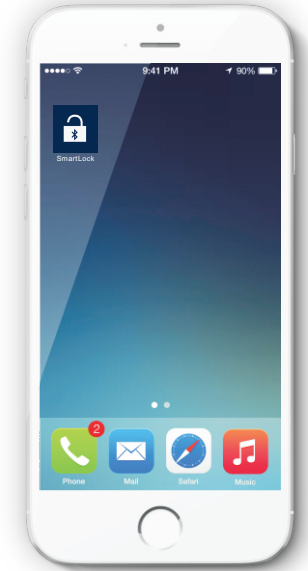
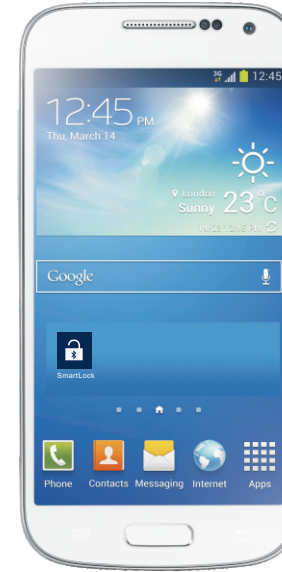

Home/Office smart lock module



Time control



Administrator /user management



4 AA batteries or wire, auto alarm for low power



E-key cloud capability



OLED display user name and lock status

Product Specification



Android 4.3 above



Blue tooth 4.0



IOS6 above



Wifi 802.11g

Circuit Characteristics

Parameter	Min	Max	Unit
<b>Operating</b>			
Operating Temperature Range	-10	70	C
Storage Temperature Range	-40	90	C
Operating Supply Voltage	6	12	V
<b>Current Consumption</b>			
Rx Mode		38	mA
Tx Mode		40	mA
Lock/Unlock trigger	200	500	mA
Sleep Mode		5	uA
<b>RF Characteristic</b>			
Frequency Range	2400	2490	MHZ
Tx Output Power	-35	4	dBm
Rx Sensitivity		-98	dBm

**LEAD BY DESIGN , NEVER FOLLOW**

Easy installation

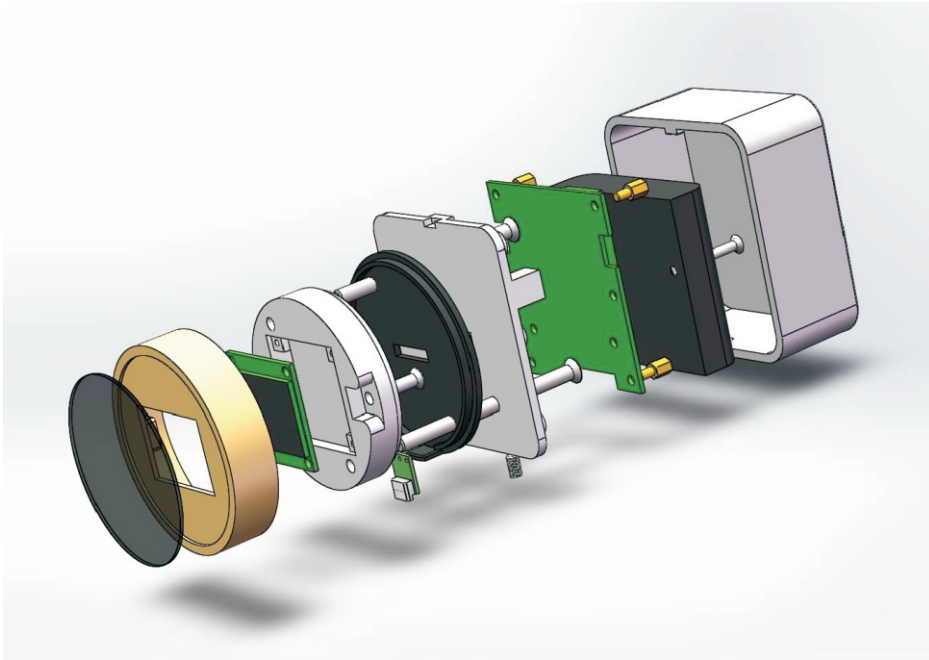

Front



Back

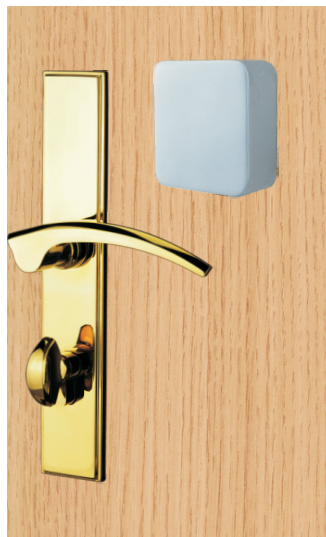

**LEAD BY DESIGN , NEVER FOLLOW**



E-key system

APP - admin/owner

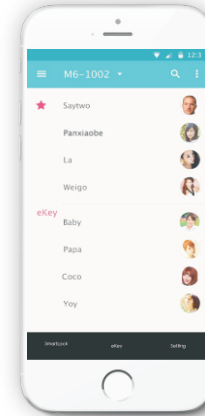

• Smart management

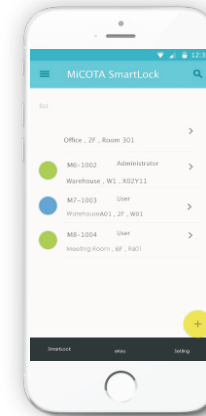

• Easy operation



• Easy to distribute ekey

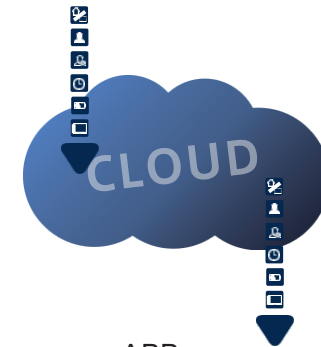

APP - user

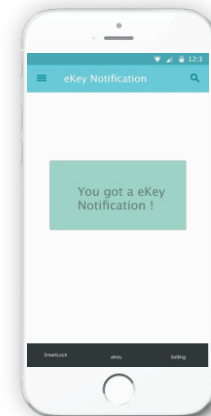

• E-key notification

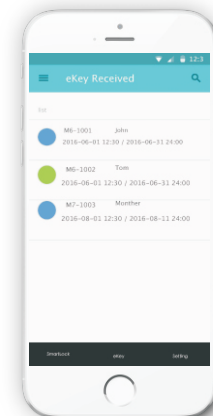

• Log information on cloud

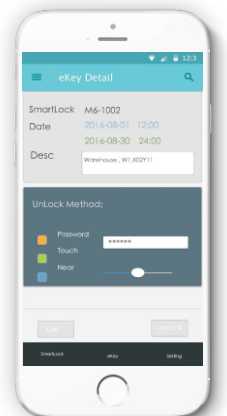

• Unlock with e-key cloud

Z-40D Solenoid lock

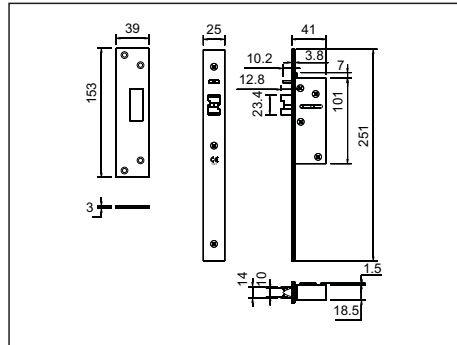
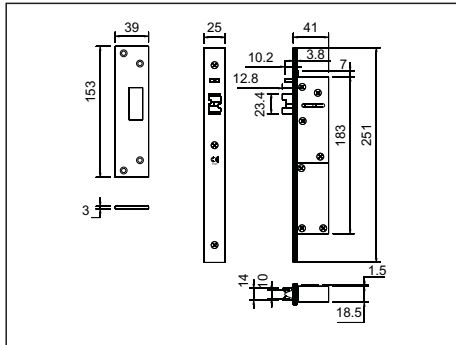

Spec & feature

- 41MM backset
- Narrow body design, universal wide
- Non handed, W/O use of handle
- Field security mode
- Special scissor latch
- Can be used for double door / single door, 180 or 90 degree angle
- Double forend , outer can match door frame
- Internal components by SS304
- Suitable door thickness 3~5mm
- Lower case can be removed for smaller mount hole

- Circuit board with waterproof design, can be used in wet environment
- Special design Inverter PCB to long life usage
- Lock / unlock mode signal output
- Input voltage AC/DC12V

E-72O Solenoid automatic deadbolt locking mortice lock

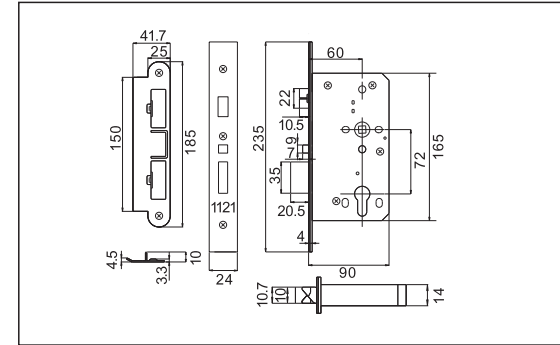
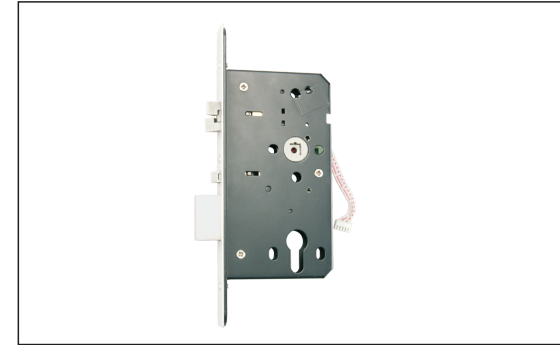

Spec & feature

- 60 MM backset
- Automatic deadbolt locking when door is closed, inside lever or turn to unlock
- Handles on both side
- Inside handle to retract deadbolt to unlock
- Spilt follower c/w fixing screw to determine LH or RH
- Special snib construction to allow deadbolt can only be thrown when latch bolt is fully engaged with strike
- Special cross latch bolt for inward or outward opening w/o handing
- Grip follower

- SS or steel cast latch/deadbolt, patented 20 MM single throw
- Heavy sprung follower
- C/w spilt spindle
- 13/26 MM rebate set available
- Square/radius faceplate, SSS/PSS/PVD
- Adjustable strike plate (option)
- Input voltage AC/DC12V
- Electrical function fail locked/unlocked
- Deadbolt locked signal
- Field security mode

D-42M Motor lock

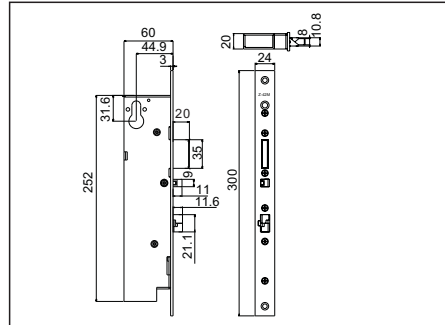
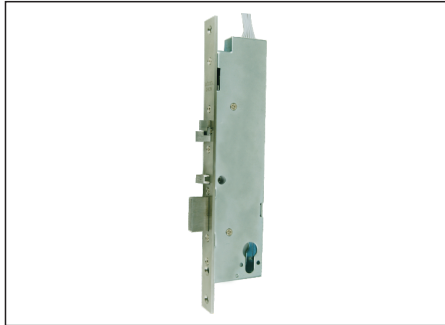

Spec & feature

- 45MM backset.
- Automatic deadbolt locking with motor drive.
- Door access system to unlock/lock.
- Deadbolt auto reset when door open.
- Special snib construction to allow deadbolt can only be thrown when latch bolt fully engaged with strike.
- SS or steel cast latch/deadbolt, patented 20 MM single throw.
- Use cylinder to unlock when emergency.
- Can apply to 180 degree opening door.
- Square/radius faceplate, SSS/PSS/PVD
- Operating voltage 12V-6V
- Deadbolt locked signal

Inverter PCB For Z-40D /E-720/D-42M

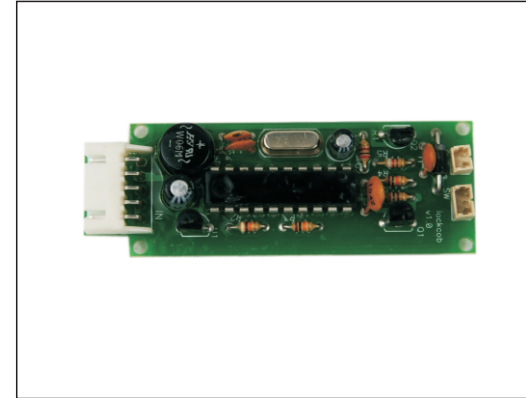

Spec & feature

- Input: 12V±10% , AC/DC
- Starting Current: 0.5An
- Operating Voltage : voltage droop to 6V after 2 sec
- Operating Current : 0.2An
- Size: L:69mm W:24mm M:12mm
- Stabilise operating voltage & standby voltage to prevent over heating

Micota E72 series architectural DIN locks

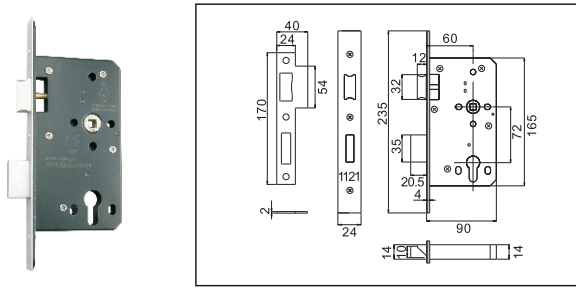

E-72S Sashlock  
 EN12209  
 Authentication Data:  
 3 X 8 1 0 G 3 B A 2 0  
 DOP NO. CE :  
 MT001

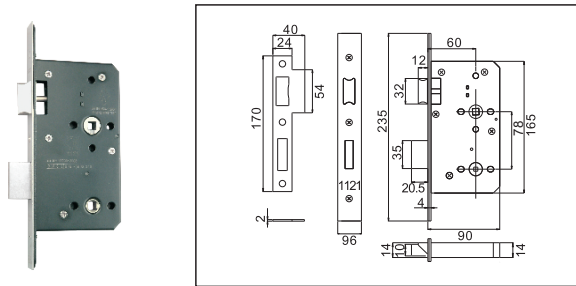

E-72B Bathroom lock  
 EN12209  
 Authentication Data:  
 3 X 8 1 0 G - B G 2 0  
 DOP NO. CE :  
 MT003

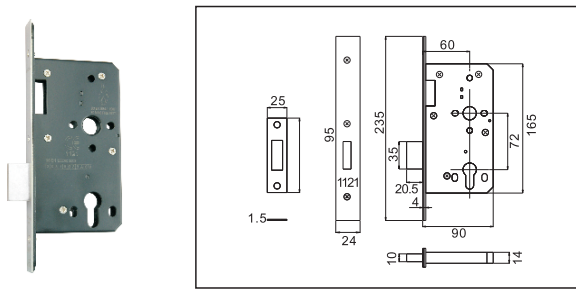

E-72D Deadlock  
 EN12209  
 Authentication Data:  
 3 X 8 1 0 G 3 B A 0 0  
 DOP NO. CE :  
 MT002

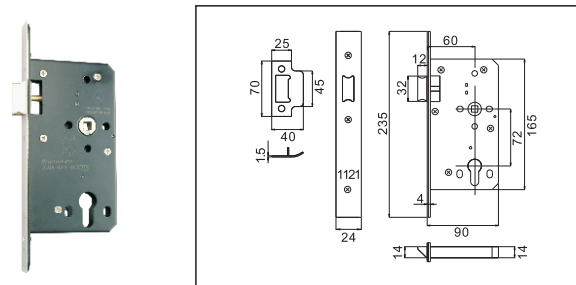

E-72U Upright latch  
 EN12209  
 Authentication Data:  
 3 X 8 1 0 G - B 0 2 0  
 DOP NO. CE :  
 MT005

- E-72S Sash lock
- E-72D Dead lock
- E-72B Bathroom lock
- E-72U Upright latch



E-72N Night latch

Spec & feature

- 60 MM backset
- Grip follower
- SS/steel cast guided latch bolt, easy reversible
- SS or steel cast latch/deadbolt, patented 20 MM single throw
- Heavy sprung follower
- 13/26 MM rebate set available
- Square/radius faceplate, SSS/PSS/PVD
- Adjustable strike plate (option)

CE standard & certificate

CE Certificated : 1121-CPD-AG0118/119/120/121/122  
 Test lab: EXOVA UK (Warrington)  
 Notified body No:1121  
 BS EN12209:2003  
 BS EN1634:-1, 60 mins fire tested  
 Certifire ref : CF5057  
 GA/T 73-1994  
 GB12955-2008

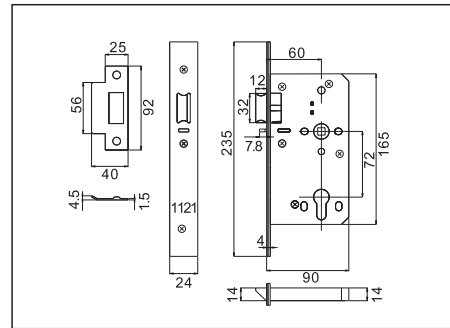

EN12209 Authentication Data:

3 X 8 1 0 G - B A 2 0

DOP NO. CE :  
 MT004

E-72N Night latch

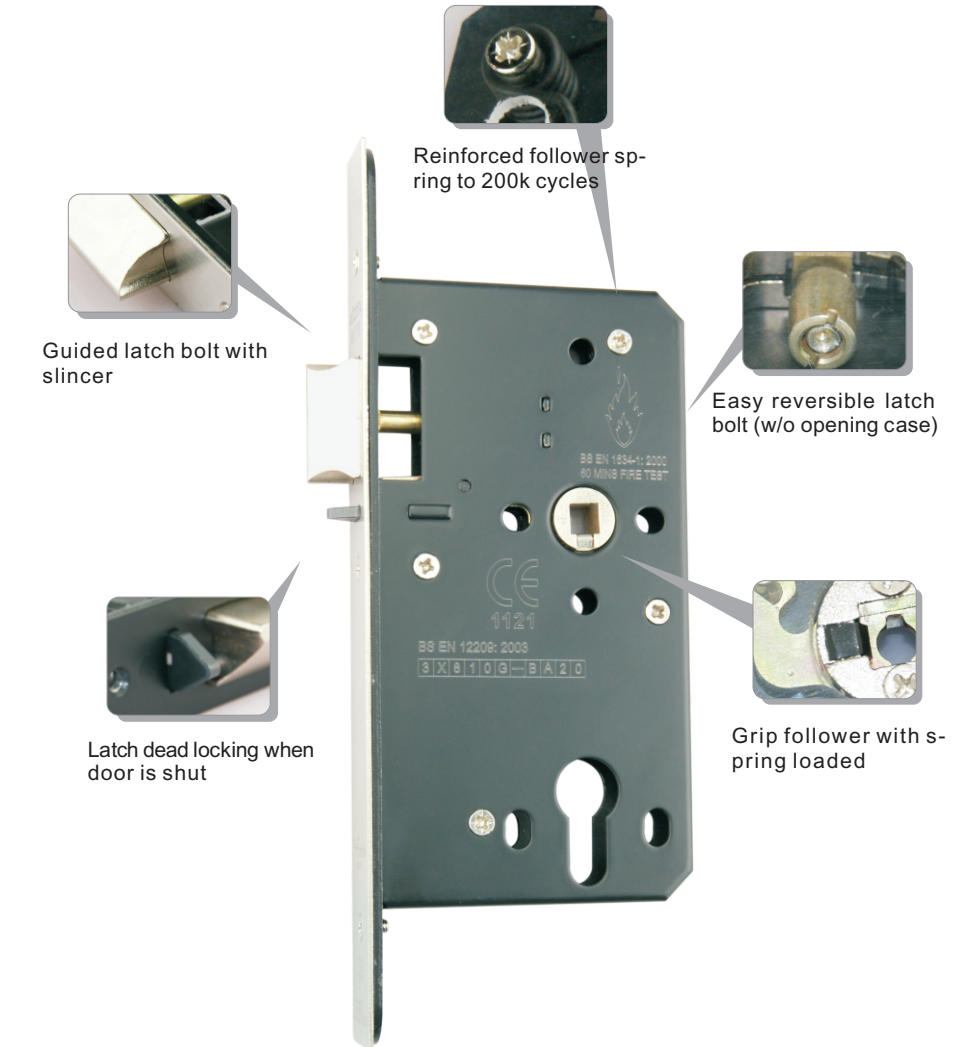



E-72P Escape lock

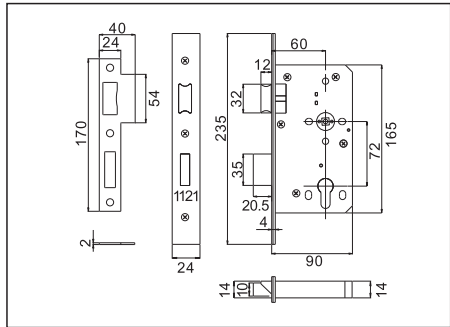

EN179 

3	7	6	B	1	3	4	2	A	B
3	7	6	B	1	3	4	2	A	D

  
 Authentication Data:  
 DOP NO. CE: MT007

CE standard & certificate

GA/T 73-1994  
 GB12955-2008  
 CE Certificated : 1121-CPD-ABB-026  
 Test lab: EXOVA UK (Warrington)

Spec & feature

- 60 MM backset
- Outside cyl key to unlock, inside lever or turn to unlock deadbolt
- Spilt follower c/w fixing screw to determine LH or RH
- Grip follower
- SS/steel cast guided latch bolt, easy reversible
- SS or steel cast latch/deadbolt, patented 20 MM single throw
- Heavy sprung follower
- C/w spilt spindle
- 13/26 MM rebate set available
- Square/radius faceplate, SSS/PSS/PVD
- Adjustable strike plate (option)

Notified body No:1121  
 BS EN 179:2008  
 BS EN1634:-1, 60 mins fire tested  
 Certifire ref: CF5057

E-72P Escape lock

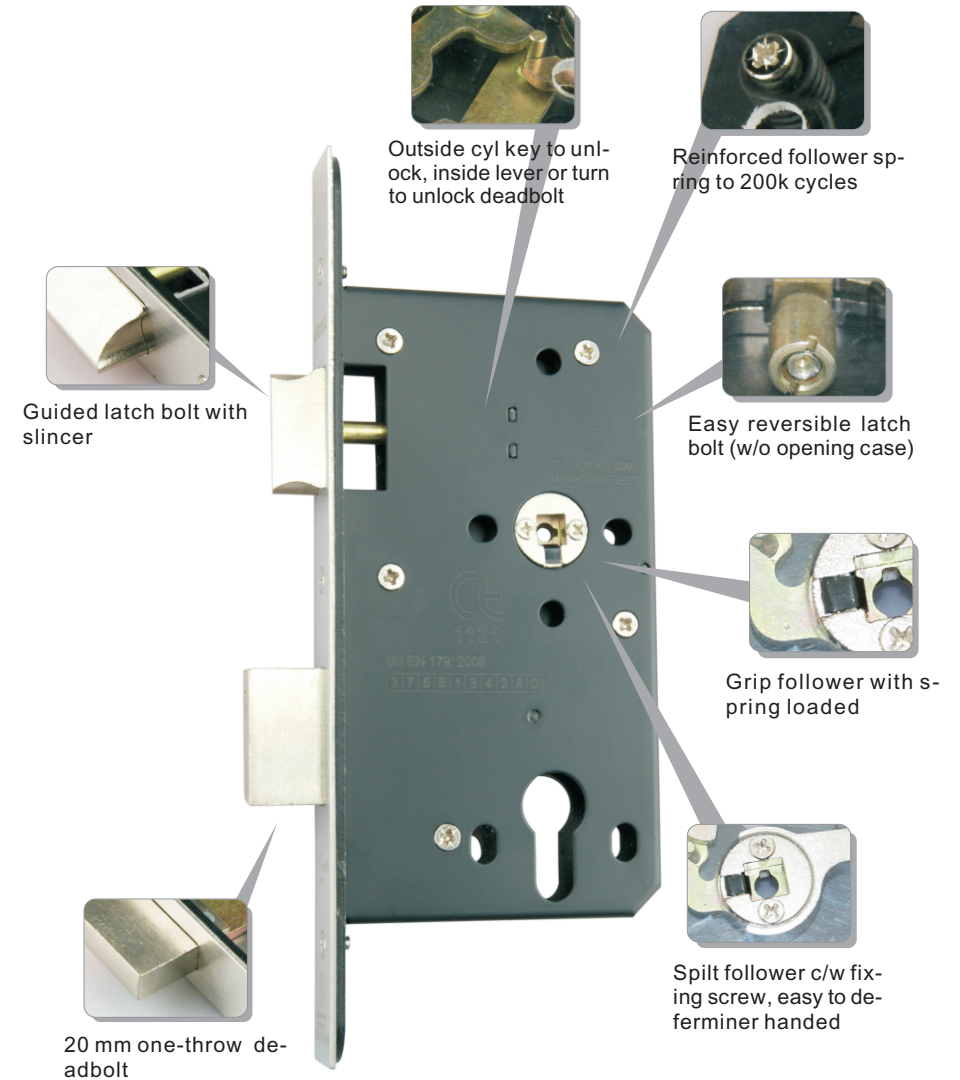

E-72A Automatic deadbolt locking mortice lock

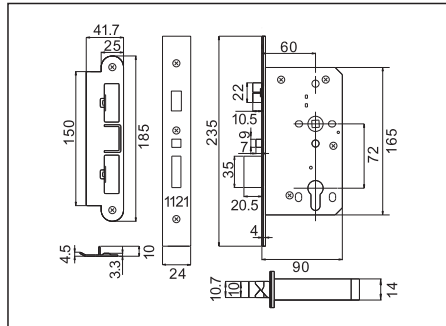

EN12209 

3	X	5	1	0	G	3	B	B	2	0
---	---	---	---	---	---	---	---	---	---	---

  
DOP NO. CE : MT006

EN179 

3	7	6	B	1	3	4	2	A	B
---	---	---	---	---	---	---	---	---	---

  
Authentication Data: 

3	7	6	B	1	3	4	2	A	D
---	---	---	---	---	---	---	---	---	---

  
DOP NO. CE : MT008

Spec & feature

- 60 MM backset
- Automatic deadbolt locking when door is closed, outside key or inside lever or turn to unlock
- Spilt follower c/w fixing screw to determine LH or RH
- Special snib construction to allow deadbolt can only be thrown when latch bolt is fully engaged with strike
- Special cross latch bolt for inward or outward opening w/o handing
- Grip follower
- SS or steel cast latch/deadbolt, patented 20 MM single throw
- Heavy sprung follower
- C/w spilt spindle
- 13/26 MM rebate set available
- Square/radius faceplate, SSS/PSS/PVD
- Adjustable strike plate (option)

CE standard & certificate

GA/T 73-1994  
GB12955-2008  
En12209:2003  
CE Certified : 1121-CPD-AG05035  
Test lab : EXOVA UK ( Warrington )

Notified body No:1121  
BS EN12209:2003  
BS EN179 : 2008  
BS EN1634:-1, 60 mins fire tested  
Certifire ref: CF5057

E-72A Automatic deadbolt locking mortice lock

Adjustable strike plate to ensure safety door gap to operate

Special cross latch bolt for inward or outward opening w/o handing

Grip follower with spring loaded

Precision of autolocking operation when door is shut (Non hand snib)

Spilt follower c/w fixing screw, easy to determine handed

20 mm one-throw deadbolt

Outside cyl key to unlock, inside lever or turn to unlock deadbolt



Super architectural UK mortice lock range

S-5D-S 5 Detainer super architectural mortice sash lock

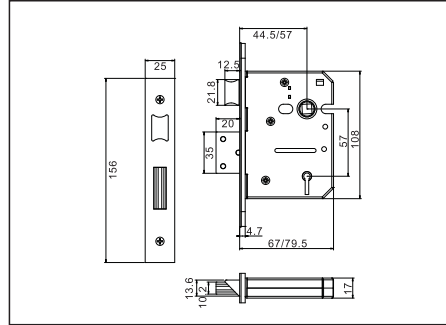

EN12209 Authentication Data:

3 | S | 8 | 1 | 0 | F | 2 | K | D | 2 | B

Spec & feature

- Sash, 63 or 76 MM case size
- Easy reversible latch bolt (w/o opening case)
- Guided latch bolt & follower
- 3MM inner forend
- 20 mm one-throw anti-saw laminated harden deadbolt
- PVD/SSS faceplate with painted metal strike box
- 13/26 MM rebate set available
- 2 steel radius cut keys
- 1500 differs number

CE standard & certificate

CE Certificate :1121-CPD-AG0109  
 BS EN12209:2003  
 BS EN1634:-1, 60 mins fire tested  
 Certifire approval: CF5058  
 DOP NO. CE : MT105



S-5D-D 5 Detainer super architectural mortice dead lock

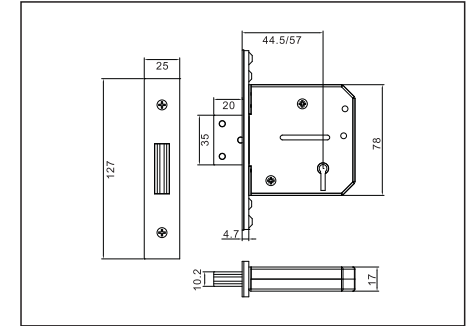

EN12209 Authentication Data:

3 | S | 8 | 1 | 0 | F | 2 | K | D | 0 | B

Spec & feature

- Dead, 63 or 76 MM case size
- 3MM inner forend
- 20 mm one-throw anti-saw laminated harden deadbolt
- PVD/SSS faceplate with painted metal strike box
- 13/26 MM rebate set available
- 2 steel radius cut keys
- 1500 differs numbe

CE standard & certificate

CE Certificate :1121-CPD-AG0109  
 BS EN12209:2003  
 BS EN1634:-1, 60 mins fire tested  
 Certifire approval: CF5058  
 DOP NO. CE : MT106



S-OV-S super oval profile sash lock

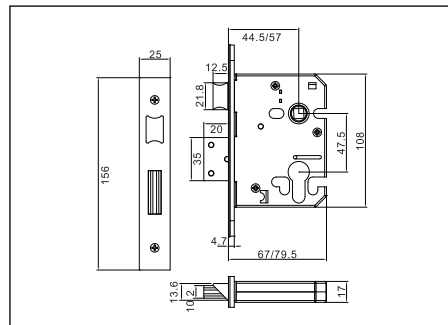

EN12209 Authentication Data:

3 | S | 8 | 1 | 0 | F | 2 | B | A | 2 | 0

Spec & feature

- Sash lock 63 or 76 MM case size
- 20 mm one-throw anti-saw laminated harden deadbolt
- Easy reversible latch bolt (w/o opening case)
- Guided latch bolt & follower
- 3MM inner forend
- PVD/SS faceplate with plate
- 13/26 MM rebate set available

CE standard & certificate

CE Certificate :1121-CPD-AG0109  
 BS EN12209:2003  
 BS EN1634:-1, 60 mins fire tested  
 Certifire approval: CF5058  
 DOP NO. CE : MT101



S-OV-D super oval profile dead lock

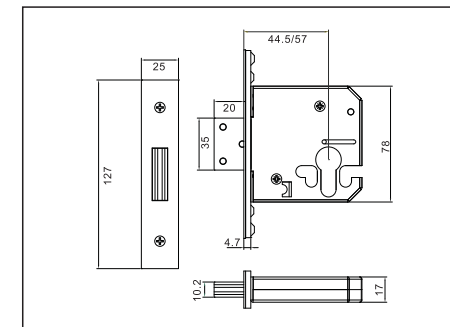
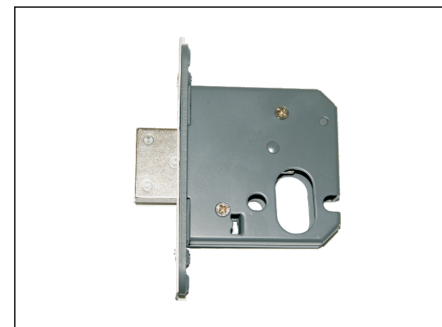

EN12209 Authentication Data:

3 | S | 8 | 1 | 0 | F | 2 | B | A | 0 | 0

Spec & feature

- Dead lock, 63 or 76 MM case size
- 20 mm one-throw anti-saw laminated harden deadbolt
- 3MM inner forend
- PVD/SS faceplate with strike plate
- 13/26 MM rebate set available

CE standard & certificate

CE Certificate :1121-CPD-AG0109  
 BS EN12209:2003  
 BS EN1634:-1, 60 mins fire tested  
 Certifire approval: CF5058  
 DOP NO. CE : MT102



S-EU-S Euro super architectural mortice sash lock

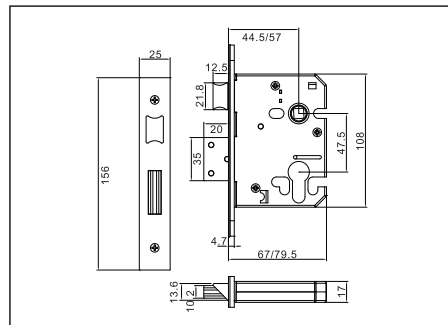

EN12209 Authentication Data:

3|S|8|1|0|F|2|B|A|2|0

Spec & feature

- Sash lock 63 or 76 MM case size
- 20 mm one-throw anti-saw laminated harden deadbolt
- Easy reversible latch bolt (w/o opening case)
- Guided latch bolt & follower
- 3MM inner forend
- PVD/SS faceplate with plate
- 13/26 MM rebate set available

CE standard & certificate

CE Certificate: 1121-CPD-AG0109

BS EN12209:2003

BS EN1634:-1, 60 mins fire tested

Certifire approval: CF5058

DOP NO. CE : MT101



S-EU-S Euro supper architectural mortice sash lock

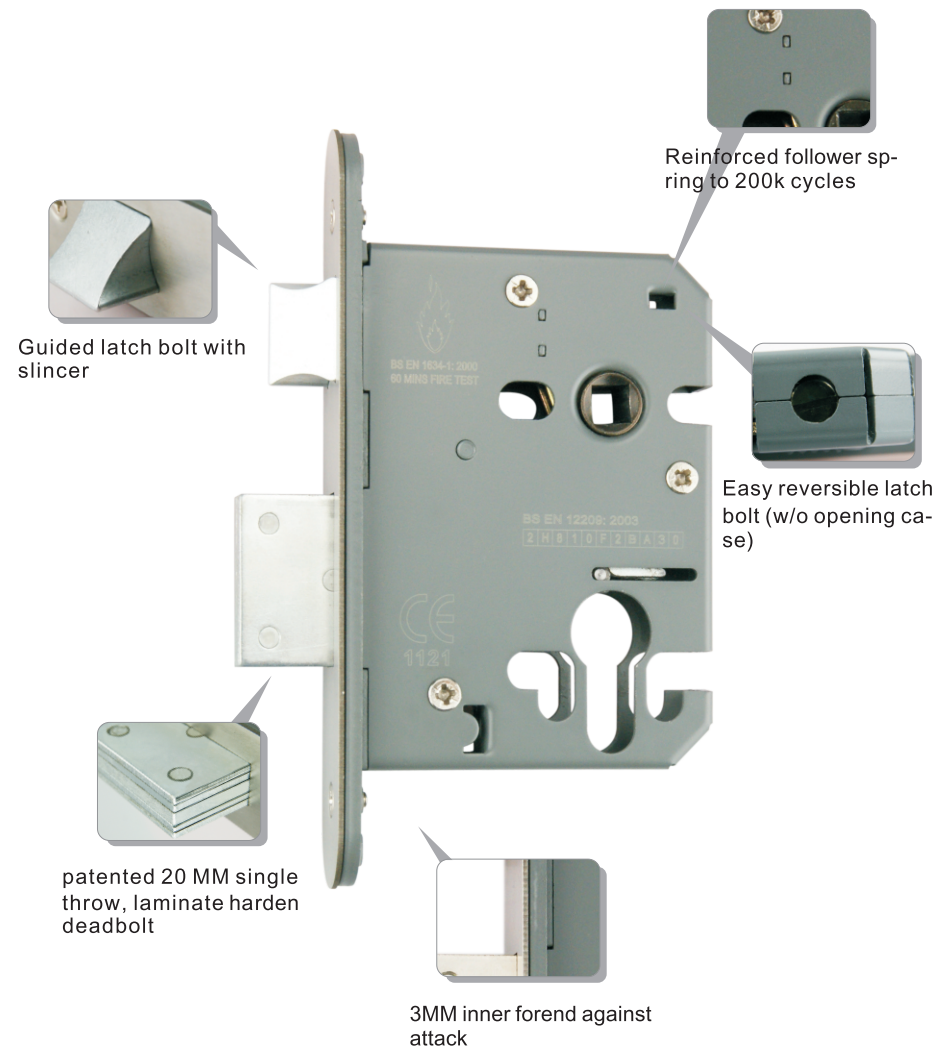

S-EU-D Euro super architectural mortice dead lock

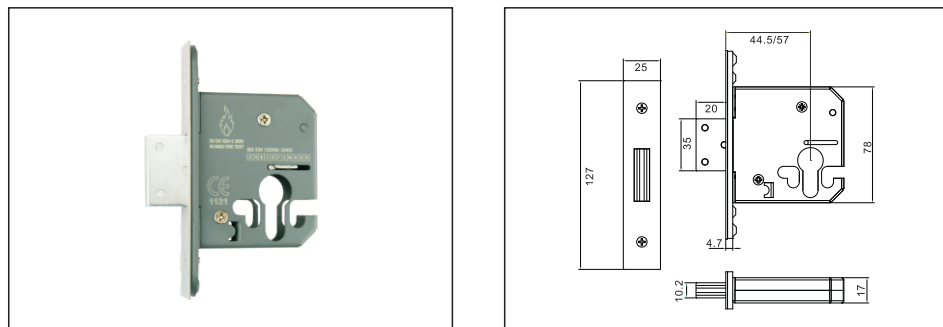

EN12209 Authentication Data:

3|S|8|1|0|F|2|B|A|0|0

Spec & feature

- Dead lock, 63 or 76 MM case size
- 20 mm one-throw anti-saw laminated harden deadbolt
- 3MM inner forend
- PVD/SS faceplate with strike plate
- 13/26 MM rebate set available

CE standard & certificate

CE Certificate :1121-CPD-AG0109  
 BS EN12209:2003  
 BS EN1634:-1, 60 mins fire tested  
 Certifire approval: CF5058  
 DOP NO. CE : MT102



S-EU-B Euro super architectural mortice bathroom lock

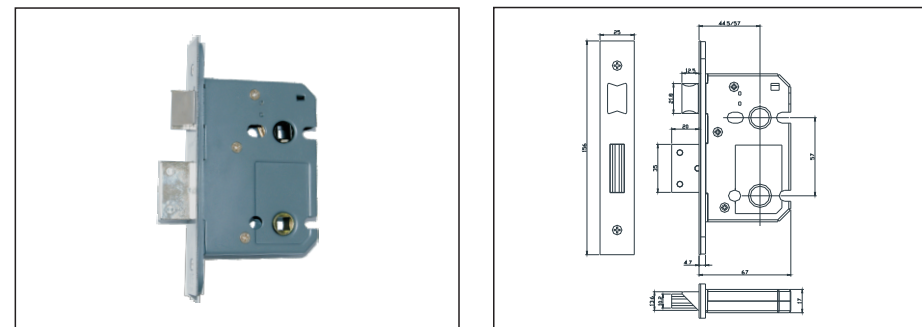

EN12209 Authentication Data:

3|S|8|1|0|F|2|B|G|2|0

Spec & feature

- 20 mm one-throw anti-saw laminated harden deadbolt
- 3MM inner forend
- PVD/SS faceplate with plate
- Std 8 mm hole, C/W 5MM adaptor 8mm

CE standard & certificate

CE Certificate :1121-CPD-AG0109  
 BS EN12209:2003  
 BS EN1634:-1, 60 mins fire tested  
 Certifire approval: CF5058  
 DOP NO. CE : MT107



BS-EU-S British standard Euro super architectural mortice sash lock

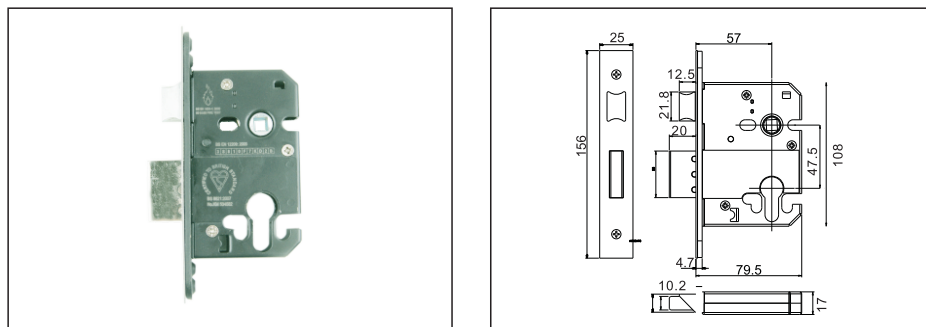

EN12209 Authentication Data:

3 | S | 8 | 1 | 0 | F | 2 | B | A | 2 | 0

Spec & feature

- Sash lock 63 or 76 MM case size
- 20 mm one-throw anti-saw laminated harden deadbolt
- Easy reversible latch bolt (w/o opening case)
- Guided latch bolt & follower
- 3MM inner forend
- PVD/SS faceplate with plate
- 13/26 MM rebate set available

CE standard & certificate

BS Certificate: KM534582  
 BS EN12209:2003 BS 3621/8621  
 BS EN1634:-1, 60 mins fire tested  
 Certifire approval: CF5058  
 DOP NO. CE : MT101



BS-EU-D British standard Euro super architectural mortice dead lock

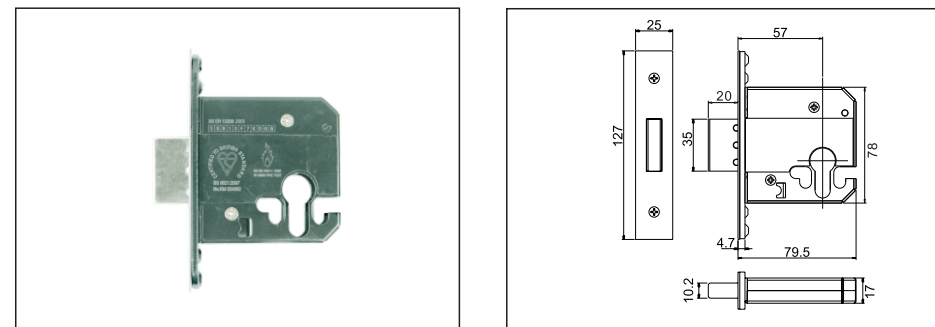

EN12209 Authentication Data:

3 | S | 8 | 1 | 0 | F | 2 | B | A | 0 | 0

Spec & feature

- Dead lock, 63 or 76 MM case size
- 20 mm one-throw anti-saw laminated harden deadbolt
- 3MM inner forend
- PVD/SS faceplate with strike plate
- 13/26 MM rebate set available

CE standard & certificate

BS Certificate: KM534582  
 BS EN12209:2003 BS 3621/8621  
 BS EN1634:-1, 60 mins fire tested  
 Certifire approval: CF5058  
 DOP NO. CE : MT102



BS-5D-S British standard super 5 lever architectural thief resistance mortice sash lock

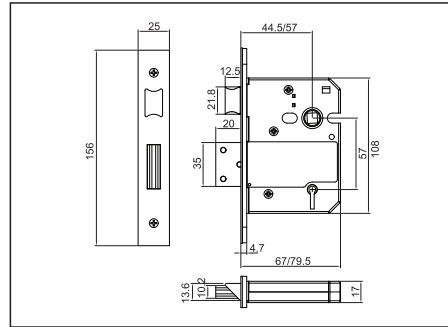

EN12209 Authentication Data:

3 S 8 1 0 F 7 K D 2 B

Spec & feature

- Sash and dead, 63 or 76 MM case size
- Steel cast hardened deadbolt
- Easy reversible latch bolt (w/o opening case)
- Guided latch bolt & follower
- Lock case weld with harden anti drill plate
- 3 MM inner forend
- PVD/SS faceplate with painted metal strike box
- 13/26 MM rebate set available
- 2 steel radius cut keys
- 1500 differs number

British standard, CE standard & certificates

BS Certificate : Km534582  
 BS3621-2007  
 BS EN12209:2003  
 BS EN1634:-1, 60 mins fire tested  
 Certifire approval: CF5058  
 DOP NO. CE : MT103

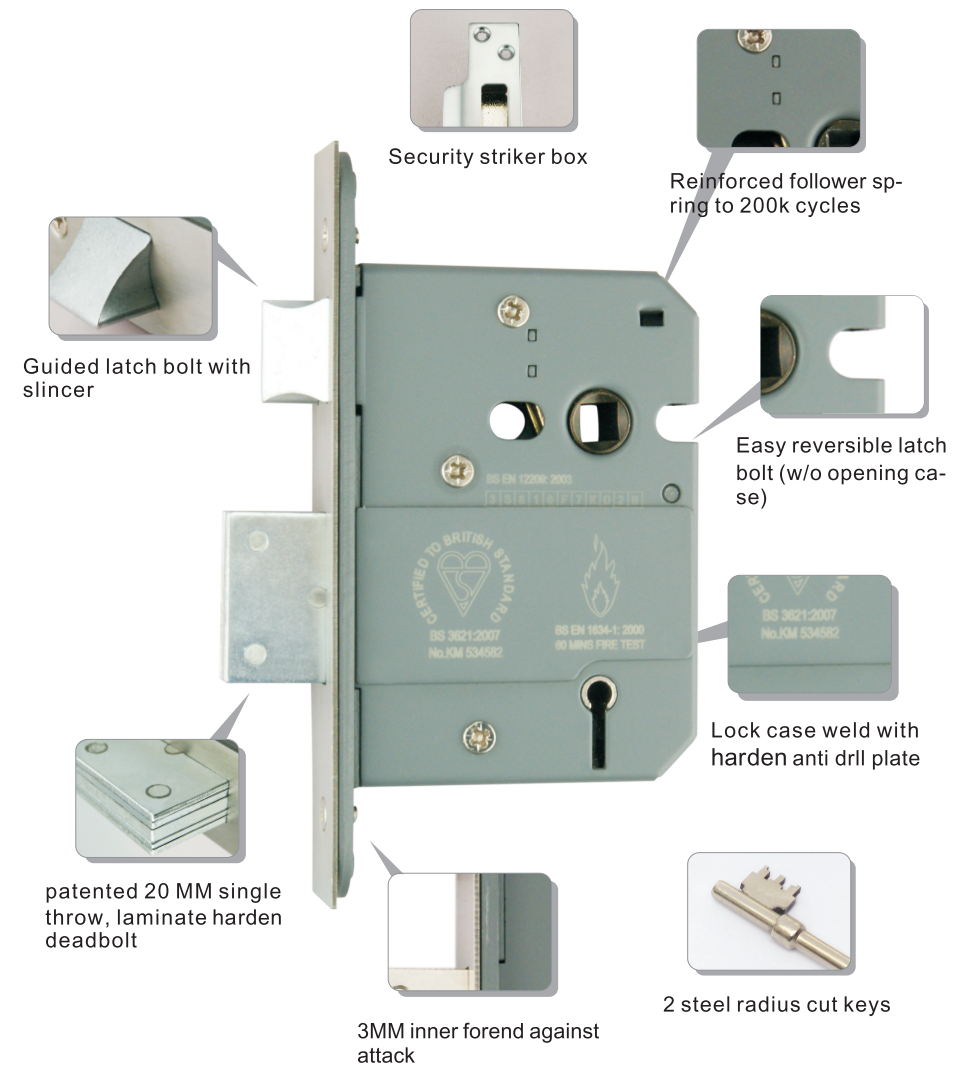



BS-5D-D British standard super 5 lever architectural thief resistance mortice dead lock

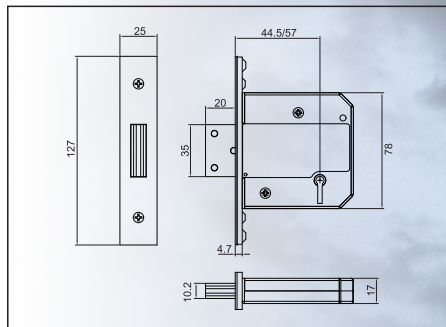

EN12209 Authentication Data:

3|S|8|1|0|F|7|K|D|0|B

Spec & feature

- Dead, 63 or 76 MM case size
- 3MM inner forend
- Lock case weld with anti drill plate
- 20 mm one-throw anti-saw laminated harden deadbolt
- PVD/SS faceplate with painted metal strike box
- 13/26 MM rebate set available
- 2 steel radius cut keys
- 1500 differs numbe

British standard, CE standard & certificates

BS Certificate: KM534582  
 BS3621-2007  
 BS EN12209:2003  
 BS EN1634:-1, 60 mins fire tested  
 Certifire approval: CF5058  
 DOP NO. CE : MT104



SC-E-DK



ANTI DRILL

This is a less subtle and destructive method that involves drilling on the Sheer Line to the depth of the key and then turning the Plug with a screw driver.



ANTI SNAP

Double euro cylinders in particular are inherently weak at the centre. Thieves have taken advantage of this and devised numerous methods of snapping these types of cylinders in a matter of seconds



ANTI BUMP

This form of attack is prevalent across Europe and disturbingly 80% of the locks tested in the Netherlands could easily be bumped within minutes, most only taking seconds!



ANTI PICK

This technique involves manipulating the pins within the euro cylinder so that they all align on the shear line and allow the Plug to be turned and the lock opened.



ANTI PLUG PULL

The Plug can be pulled from standard euro cylinders by simply tightening a screw into the Keyway and then levering or pulling the screw with a claw hammer.



Using the technologically advanced automatic lock protection system (ALPS) the cylinder will optimise safety and security. The ALPS three star security cylinder is the latest in the range of micota security products.

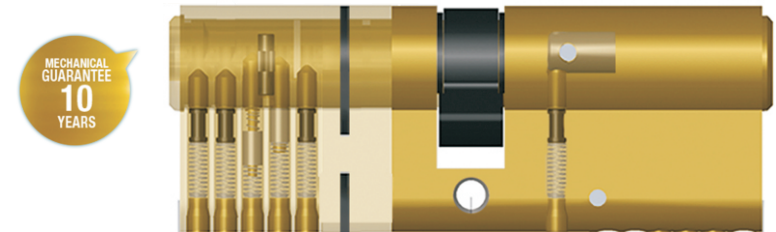

British standard, CE standard & certificate

BS Certificate: KM597142

BS EN	1	6	0	1	0	C	6	2
-------	---	---	---	---	---	---	---	---

BS EN 1303:2015

BS EN1634:-1, 60 mins fire tested

TS007 2014+A1:2015

PAS 24

**LEAD BY DESIGN , NEVER FOLLOW**